



www.buzon.eu

The PB Pedestal

The range

The PB pedestal is Buzon's latest adventure, and is a friend to all.

They are adjustable from 28 to 955 mm, and are perfect for creating residential spaces.

Its ergonomics make the PB pedestal easy to adjust and allows quick and reliable installation. The enlarged surface of the head of the PB pedestal is specially adapted for the laying of very thick ceramic tiles, concrete or natural stone pavers, or a floor made of wooden or composite boards.



Accessories

Spacer tabs and levellers

The spacers are 2, 3 or 4.5 mm thick and 17 mm high, are fixed in place by pressure on BUZON pedestals from the PB range. The spacers regulate the spacing between the pavers, ensure alignment and allow the rapid evacuation of excess water.

The U-E20 leveller is a 2 mm clover-shaped shim. Placed on the Buzon pedestal, it stabilises the paver, provides additional acoustic comfort, and because it can be split, compensates for variations in paver thickness. The leveller is also available in 1 mm thick.

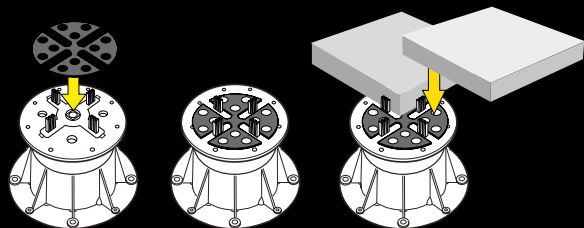

Slope corrector

The slope corrector is an adjustable plate to be placed under the base of BUZON pedestals from the PB range. It controls slopes measured with the U-KIT-SL80 spirit level. A horizontal or inclined terrace can be obtained as required.

The total height of the pedestal will increase by 14mm.

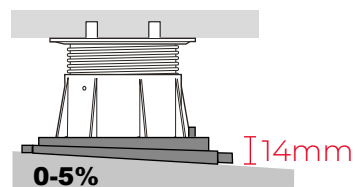
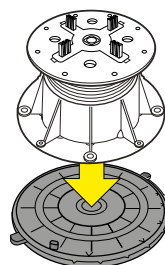

Finishing kit

The Buzon PB-END Finishing Kit wraps the edge of the space created beneath the deck installed on pedestals from the PB range. Two blades with claws encircle the 20 mm-thick plinth.

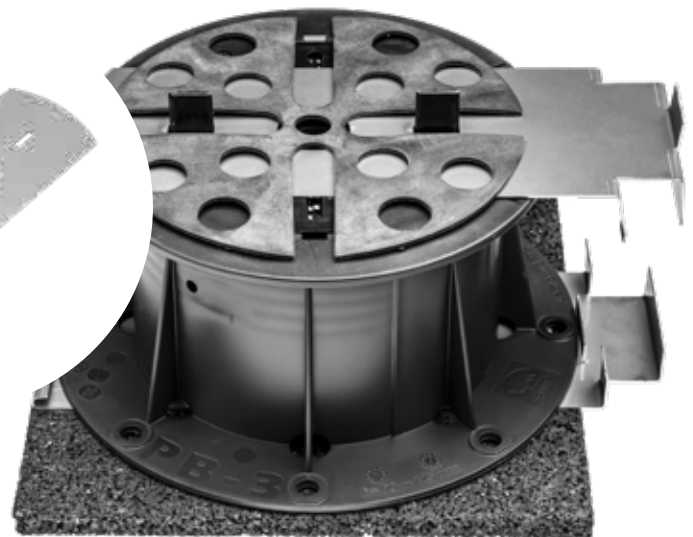
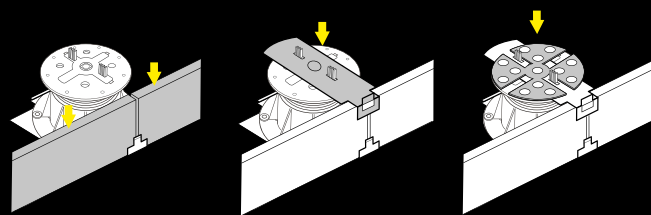

BSW Regupol: Acoustic Insulation up to 37dB.

U-BRS (Buzon Rail System)

Aluminium joists allow and facilitate the installation of 20 mm ceramic tiles of all sizes. The time saved and the increased stability of the structure will delight professionals. Its thickness of 38 mm provides greater strength for applied loads and requires spacing of only 80 cm between each support pedestal.

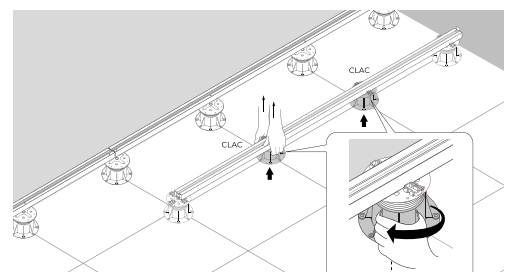
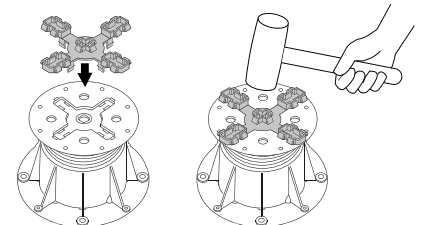

Joist support

The PB-KIT5 support for joists is fixed in place by pressing on the BUZON pedestals from the PB range. It effectively secures the joist and the pedestal to create wooden or composite decking.

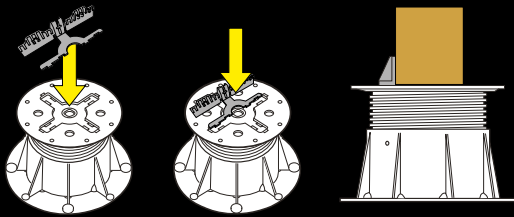

Average number of pedestals per m²:

Deck size	20 m ²	50 m ²	100 m ²
Paver format	pedestals/ m²	pedestals/ m²	pedestals/ m²
40 x 40 cm	7.70	7.28	6.76
50 x 50 cm	4.95	4.62	4.41
60 x 60 cm	4.00	3.57	3.30
75 x 75 cm	4.87	4.40	4.11
80 x 80 cm	4.36	3.92	3.64
90 x 90 cm	6.54	5.98	5.62
100 x 100 cm	5.45	4.94	4.62
120 x 60 cm	4.00	3.60	3.24
90 x 45 cm	6.50	6.24	5.76

These are indicative numbers only, as exact numbers will be different based on each project's requirements, etc. Buzon cannot take any responsibility for deviating numbers.

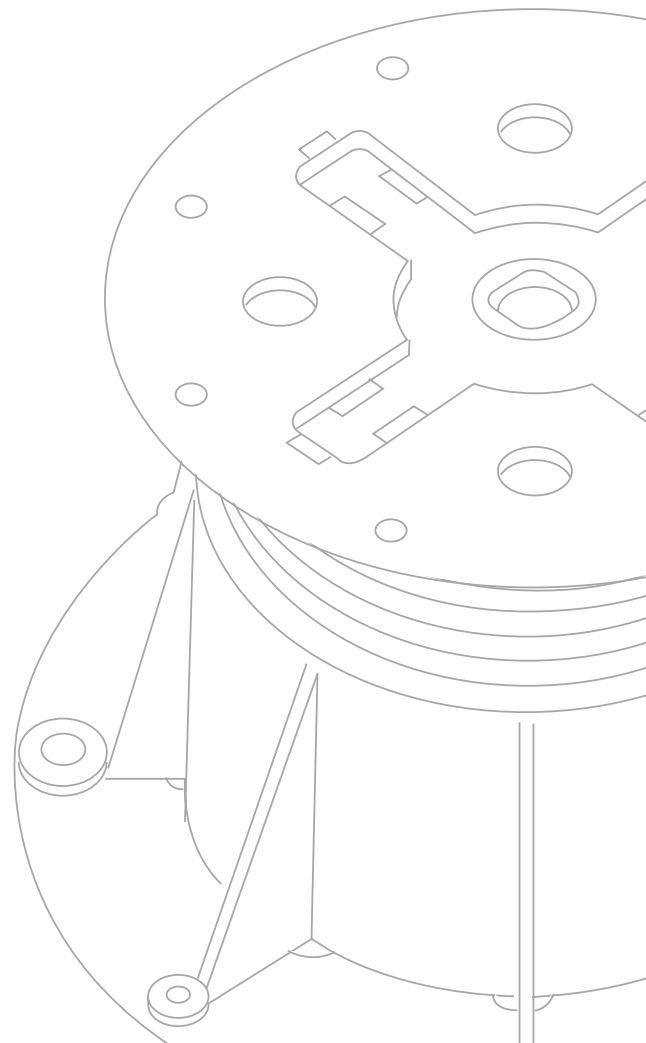

Our partners around the world



References

- Marina Bay Sands Integrated Resorts, Singapore
- One World Trade Center, New York
- Disneyland, Paris - France
- Burj Khalifa, Dubai
- Excel, London, U.K.
- Wynn Resort & Casino Hotel, Las Vegas, USA
- CapitaGreen, Singapore
- Sydney Cove Passenger Terminal, Australia
- The docks of the Seine, Paris, France
- Grand Hyatt Hotel, Tokyo, Japan

